







**DRUŠTVO S OGRANIČENOM ODGOVORNOŠĆU ZA
PROJEKTOVANJE, PROIZVODNJU
USLUGE, TRGOVINU I ZASTUPANJE BANJA LUKA**
Ramići bb, 78000 Banja Luka, RS-Bosna i Hercegovina
Uprava Tel/fax: +387 51 394 076; info@tribestbl.com
Prodaja: 051 392 093; Fax: 394 106; veleprodaja@tribestbl.com
www.tribestbl.com
PIB: 400802520002 MB: 1863371 MBS: 1-8737-00



Ž.R. 551 0010000 350490 UNICREDIT BANK a.d. B. Luka; 567 16211000 73168 VOLKSBANK a.d. B.Luka

LIFTOVI-KOMPONENTE

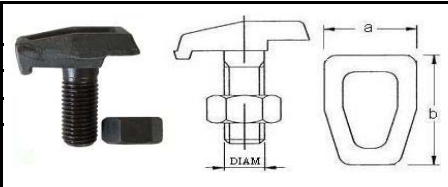
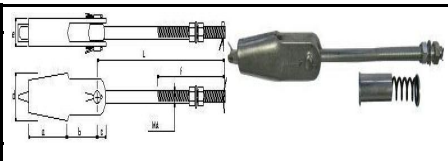
Šifra	Naziv robe			Fotografija
511770	BATERIJA 12V 1.3Ah			
460140	ZVONCE ZA ALARM RSV 12/24V 50ma			
150410	ODBOJNIK POLIURETAN Ø125x100			
571501	ELEKTRO PLOČA ZA LIFTOVSKA BUS VRATA			
110010	KANJETA M10			
110020	KANJETA M12			
110030	KANJETA M14			
110040	KANJETA M16			
220020	SIDRO ZA SAJLU MA12 za žicu Ø6 do Ø8 L-300			
220030	SIDRO ZA SAJLU MA19 za žicu Ø9 do Ø11 L-300			
220050	SIDRO ZA SAJLU MA20 za žicu Ø12 do Ø14 L-300			
220320	SIDRO ZA SAJLU MA20 za žicu Ø12 do Ø14 L-400			

220080	SIDRO ZA SAJLU MA16 za žicu Ø12 round		
--------	--	--	--

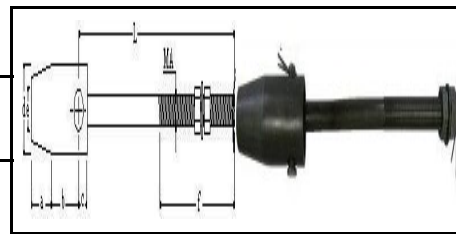

220090	OPRUGA ZA SIDRO MA16 D-35 L-120 Q-		
220355	OPRUGA ZA SIDRO MA20 D-45 L-140 Q-		
220360	OPRUGA ZA SIDRO MA20 D-47 L-150 Q-		

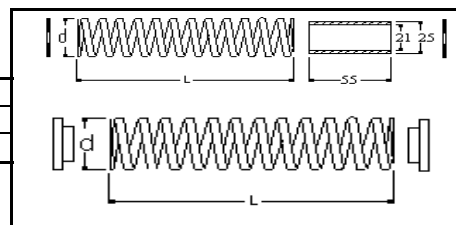

310360	ŠLEP KABAL HO5VVH6-F 16G0,75 black		
310400	ŠLEP KABAL HO5VVH6-F 20G0,75 black		
310440	ŠLEP KABAL HO5VVH6-F 24G0,75 black		

oznaka	konsrtukcija	kg/m	Dimenzija mm
310290	4G0,75	0,091	4,2X12,6
310300	6G0,75	0,143	4,2X18,4
310310	8G0,75	0,175	4,2X23,2
310315	9G0,75	0,201	4,2X26,6
310320	12G0,75	0,260	4,2X33,8
310360	16G0,75	0,337	4,2X44,4
310400	20G0,75	0,429	4,2X0,55
310440	24G0,75	0,513	4,2X65,6

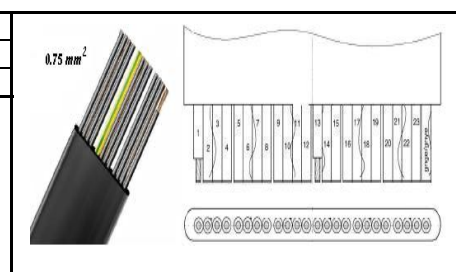

730010	DIKTATOR EVROPA		
730070	DIKTATOR SCHINDLER		



430115	FOTOČELIJA 12/24V AC/DC 1 SNOP		
430150	FOTOČELIJA SA OPTIČKIM SENZOROM		

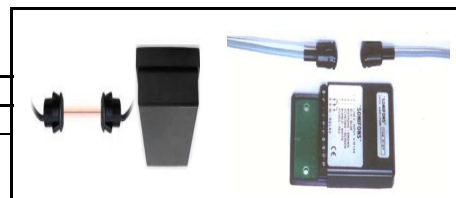

210230	ČELIČNO UŽE Ø6,5		
210110	ČELIČNO UŽE Ø8		
210140	ČELIČNO UŽE Ø9		
210170	ČELIČNO UŽE Ø11		
210210	ČELIČNO UŽE Ø13		

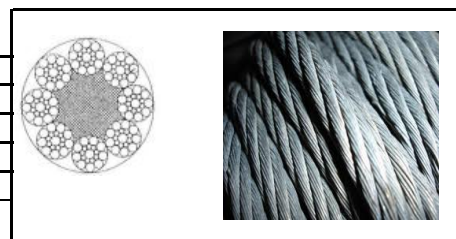

oznaka	dimenzija mm	smjer	Outer wires d. mm	Section mm ²	Cabling factor	Min. breaking load kN	Mass kg/m
210110	8	sZ (right)	0,53	22,34	0,84	29,40	0,223
210120	8	zS (left)	0,53	22,34	0,84	29,40	0,223
210130	9	sZ (Right)	0,60	28,27	0,84	37,30	0,282
210140	9	zS (left)	0,6	28,27	0,84	37,30	0,282
210150	10	sZ (right)	0,65	34,90	0,84	46,00	0,348
210160	10	zS (left)	0,65	34,90	0,84	46,00	0,348
210170	11	sZ (right)	0,73	42,23	0,84	55,70	0,422
210180	11	zS (left)	0,73	44,40	0,84	55,70	0,422
210190	12	sZ (right)	0,80	50,26	0,84	66,20	0,502
210200	12	zS (left)	0,80	53,10	0,84	66,20	0,502
210210	13	sZ (right)	0,87	58,98	0,84	77,70	0,589
210220	13	zS (left)	0,87	58,98	0,84	77,70	0,589
210230	15	sZ (right)	0,98	78,53	0,84	104,00	0,784
210240	15	zS (left)	0,98	78,53	0,84	104,00	0,784
210250	16	sZ (right)	1,03	89,34	0,84	118,00	0,90

510210	MAGNETNI SENZOR		
--------	-----------------	--	--



510110	BISTABILNI SENZOR 250V 1,3A		
--------	-----------------------------	--	--



560610	KRAJNI PREKIDAČ FR555-4		
560641	KRAJNI PREKIDAČ FR1655		
560650	KRAJNI PREKIDAČ FR5A3		
560652	KRAJNI PREKIDAČ FR501		
560654	KRAJNI PREKIDAČ FR515		
560684	KRAJNI PREKIDAČ FR605-W		

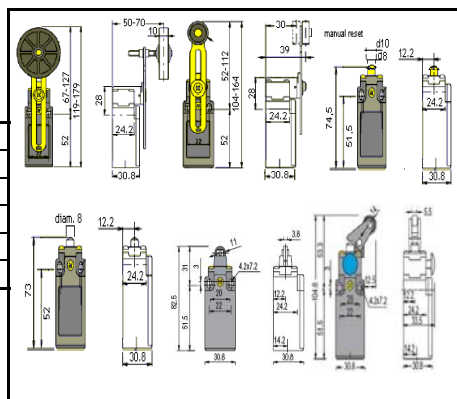

810420	GUMENI AMORTIZER 50X25M 10X28X28		
810460	GUMENI AMORTIZER 75X30M 12X37X37		

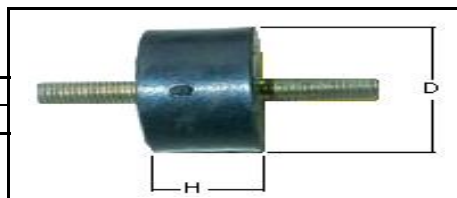

552110	DUGME SA KLJUČEM 1 G9225		
552120	DUGME SA KLJUČEM 2 G9225		



450110	PANIK SVJETLO 50lm AB26		
--------	-------------------------	--	--

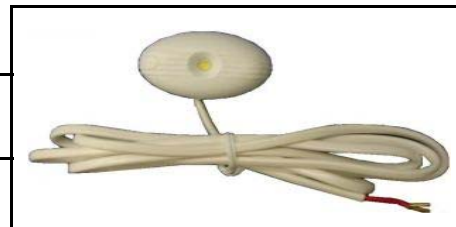

450120	BATERIJA ZA PANIK SVJETLO 3h		
--------	------------------------------	--	--

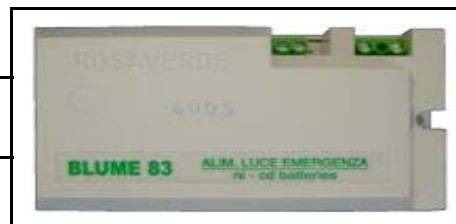

230120	STEZALJKA ZA UŽE Ø5-6mm		
230130	STEZALJKA ZA UŽE Ø7-8mm		
230140	STEZALJKA ZA UŽE Ø9-10mm		

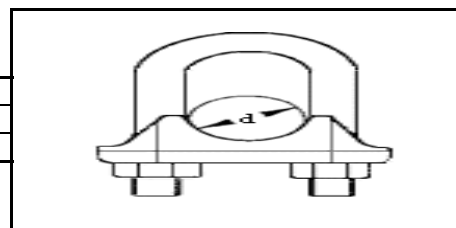

620110	KLIZAČ PROTIVTEGA 37mm C.5.5		
620120	KLIZAČ PROTIVTEGA 37mm C.6.5		
620130	KLIZAČ PROTIVTEGA 37mm C.7.5		

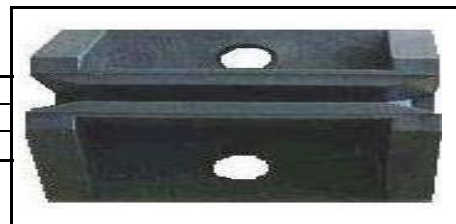

160010	MAZALICA ZA VOĐICU-VISOKA		
160030	MAZALICA ZA VOĐICU-NISKA		
160080	SKUPLJAČ ULJA ŠINE	11.73	6.00

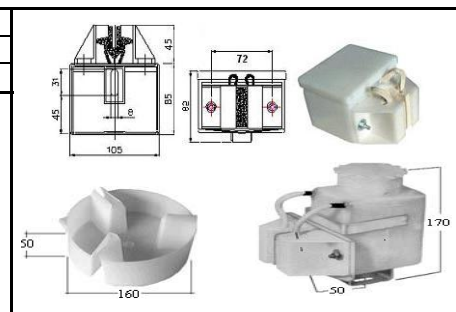



SKLOP MONTAŽE MAZALICE NA VOĐICU

150140	OPRUGA ZA ODBOJNIK d-14 L-235mm					
150210	OPRUGA ZA ODBOJNIK d-14 L-330mm					
oznaka	dimenzija opruge	dužina	hod	nominalna brzina		
150140	14	235	74,70	0,74		
150150	15	210	71,25	0,73		
150160	16	225	77,00	0,76		
150180	18	250	73,60	0,74		
150210	14	330	138,90	1,01		
150220	15	330	141,75	1,02		
150230	18	420	134,70	1,00		

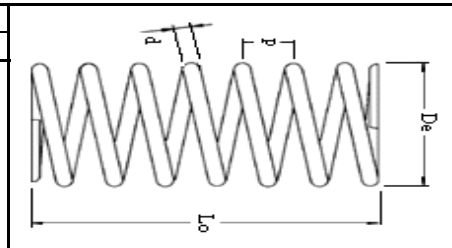

250050	HVATAČKI UREDJAJ SP50						
oznaka	tip	uže	0,60 m/s	0,80 m/s	1,00 m/s		
250050	sp50	6/16 mm	3128 kg	2853 kg	2564 kg		

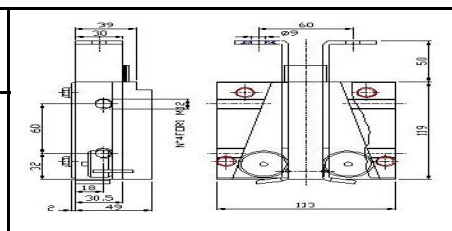

250072-3	HVATAČKI UREDJAJ 9mm					
250080-1	HVATAČKI UREDJAJ 16mm					
oznaka	strana	A mm	B mm	D mm		
250072	desni	90	100	40		
250073	lijevi	90	100	40		
250080	desni	120	120	60		
250081	lijevi	120	120	60		
E mm	uže	0,60 m/s	0,80 m/s	1,00 m/s		
10	9 mm	2467 kg	2251 kg	2022 kg		
10	9 mm	2467 kg	2251 kg	2022 kg		
15	16 mm	2628 kg	2397 kg	2154 kg		
15	16 mm	2628 kg	2397 kg	2154 kg		

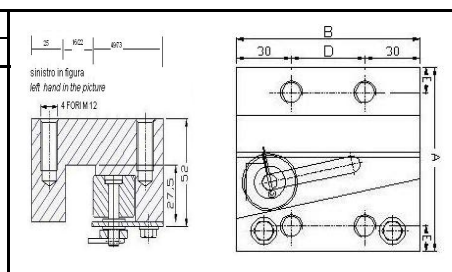

540210	MAGNETNI ODBOJNIK 60V				
---------------	------------------------------	--	--	--	--

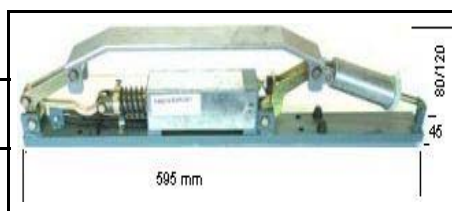

550010	KABINSKA DOZA M445		
--------	--------------------	--	--



550245	TASTER STOP		
--------	-------------	--	--



260620	UŽETNJAČA D360 N4XD9		
260660	UŽETNJAČA D400 N4XD10		
260680	UŽETNJAČA D450 N4XD11		
260130	UŽETNJAČA D450 N5XD9-11		

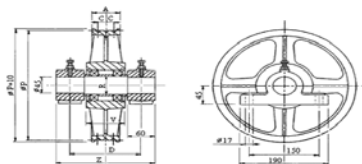

oznaka	P	No. Grooves	Uže mm	D.	A	C	V	Z	D	R
260004	240	6	8		111	17	120	240	180	55
260006	320	6	8		111	17	102	240	180	55
260008	320	3	8		60	17	82	215	155	50
260009	320	4	8		77	17	82	215	155	50
260010	360	3	8		60	17	82	215	155	50
260020	360	4	8		77	17	82	215	155	50
260060	400	3	9		60	17	82	215	155	50
260070	400	4	9		77	17	82	215	155	50
260075	400	5	9		94	17	102	240	180	55
260080	400	6	9		111	17	102	240	180	55
260110	450	3	9		60	17	82	215	155	50
260120	450	4	9		77	17	82	215	155	50
260130	450	5	9		94	17	102	240	180	55
260140	450	6	9		111	17	102	240	180	55
260160	500	3	9		60	17	82	215	155	50
260170	500	4	9		77	17	82	215	155	50
260180	500	5	9		94	17	102	240	180	55
260190	500	6	9		111	17	102	240	180	55
260210	550	3	9		60	17	82	215	155	50
260212	550	4	9		77	17	82	215	155	50
260215	550	5	9		94	17	102	240	180	55
260218	550	3	13		77	20	102	240	180	55
260220	550	4	13		94	20	102	240	180	55
260230	550	5	13		111	20	102	240	180	55
260240	550	6	13		130	20	122	260	200	60
260250	550	8	13		170	20	162	300	240	65
260260	600	3	9		60	17	82	215	155	50
260270	600	4	9		77	17	82	215	155	50

250050	NOSAČ KLIZAČA 2500daN		
--------	-----------------------	--	--

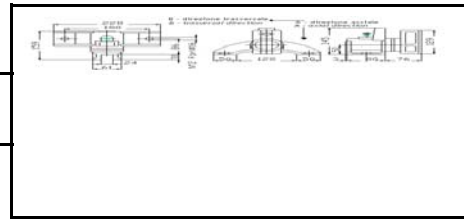

270070-16	KLIZAČ ZA RAM T600 130X130 C16,5		
-----------	----------------------------------	--	--



410050	TRANSFORMATOR		
--------	---------------	--	--

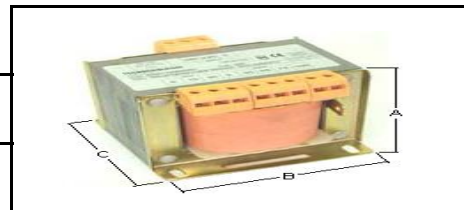

530010/28	BRAVA ZA POLUAUTOMATSKA VRATA		
-----------	-------------------------------	--	--



530140	KONTAKT ZA BRAVU TIEFFE		
--------	-------------------------	--	--



420030	GREC 1000V 25A		
--------	----------------	--	--



Minimalna širina hvatanja: 25mm			
Prihvatljiva dimenzija vodice: 8 do 16 mm			
PR2500UDV35	HVATAČKI UREĐAJ DYNATECH		
PQ4000UD B1	HVATAČKI UREĐAJ DYNATECH		
Ukupna težina: maksimalna P+Q-1700kg minimalna P+Q-741			
Nazivna brzina: 2.0m/s do 2.5m/s			



Nazivna brzina :0.1 m/s min-2.3 m/s max			
Granična brzina :0.8 m/s min.-2.74 m/s max			
Užetnjača : 200mm			
LBD200	GRANIČNIK BRZINE		
LBD300	GRANIČNIK BRZINE		
Uže: 6mm, 6.3mm y 6.5mm			
Daljinski upravljački uređaj: 24, 48 ili 190 VDC			
Daljinski sistem uključivanja: 24, 48 ili 190 VDC			

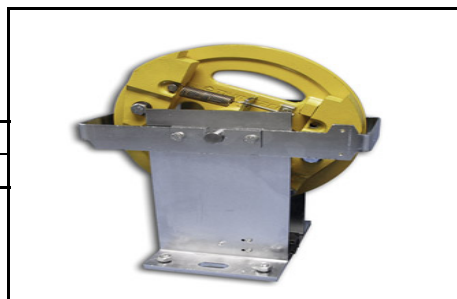

128X64	DISPLEJ LCD		
128X240	DISPLEJ LCD		

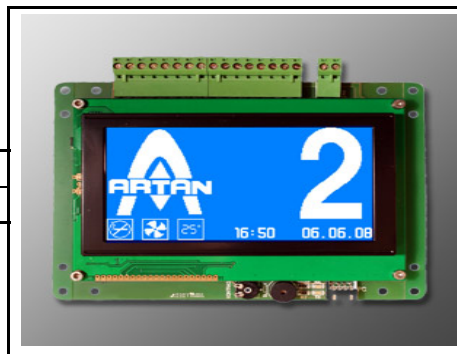

01 01 00	BRAVA ZA VRATA LIFTA-LIJEVA		
02 01 00	BRAVA ZA VRATA LIFTA-DESNA		
05 02 00	BRAVA ZA VRATA LIFTA-DUPLA		

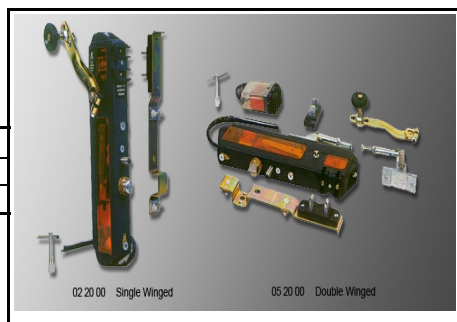

ŠINE - VODILICE ZA LIFTOVE

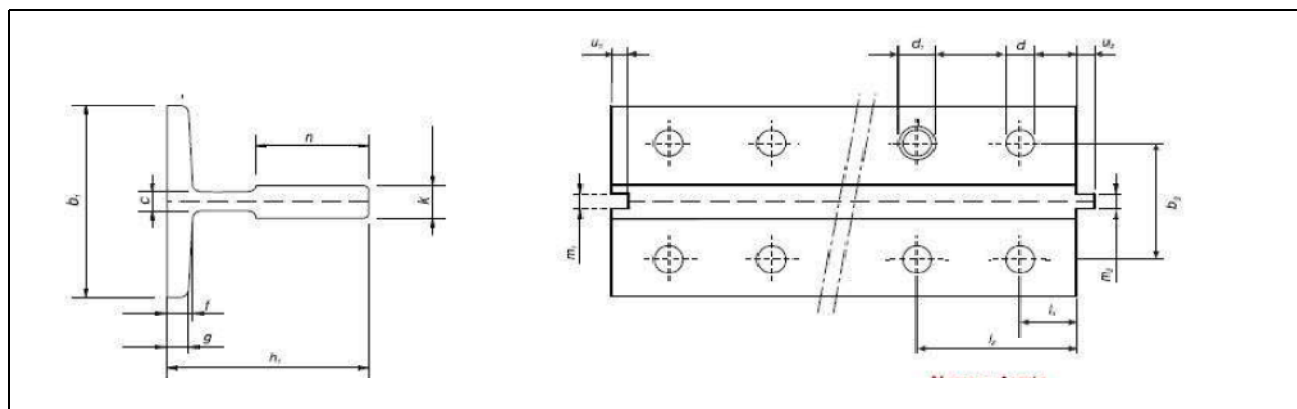

Dimenzije	Kota prema skici								Cijena po komadu	
ISO 7465	b1	h1	k	p	m1	m2	u1	u2	KM	EUR
T50/A	50	50	5	5	2	1.95	2.5	2		

Dimenzije	Kota prema skici								Cijena po komadu		
ISO 7465	b1	h1	k	n	c	f	g	m1	m2	KM	EUR
T70/A	70	65	9	34	6	8	6	3	2.97		
T90/A	90	75	16	42	10	10	8	6.4	6.37		
T125B	125	82	16	42	10	12	9	6.4	6.37		

Tehničke karakteristike	S	q1	e	Ix-x	Wx-x	ix-x	Iy-y	Wy-y
ISO 7465	cm ²	Kg/m	cm	cm ⁴	cm ³	cm	cm ⁴	cm ³
T50/A	4.75	3.73	1.43	11.24	3.15	1.54	5.25	2.1
T70/A	9.4	7.379	2.034	40.95	9.169	2.087	18.86	5.389
T90/A	17.25	13.54	2.612	102	20.86	2.431	52.48	11.66
T125B	22.82	17.91	2.43	151	26.16	2.572	159.1	25.46

Spojne ploče i kanjete							Vijak	Kanjeta
ISO 7465	d	l1	l2r	l3f	b2	b3	EN4017	DIN7168
T50/A	9	200	75	25	50	30	M8x25	M1
T70/A	13	250	105	25	70	42	M12x35	M2
T90/A	13	305	114.3	39.1	90	57.2	M12x40	M2
T125B	17	305	114.3	38.1	130	79.4	M16x50	M4

SPRATNA AUTOMATSKA VRATA - EPOXI

Fermator
AUTOMATIC DOORS FOR LIFTS

	KM	EUR
Vrata spratna automatska - T2, 800x2000, RAL 7035		
Vrata spratna automatska - T2, 900x2000, RAL 7035		
Vrata spratna automatska - T2, 1000x2000, RAL 7035		
Vrata spratna automatska - T2, 1100x2000, RAL 7035		
Vrata spratna automatska - T2, 1200x2000, RAL 7035		
Vrata spratna automatska - T2, 1300x2000, RAL 7035		
Vrata spratna automatska - T2, 1400x2000, RAL 7035		
Vrata spratna automatska - T2, 1500x2000, RAL 7035		
Vrata spratna automatska - C4, 700x2000, RAL 7035		
Vrata spratna automatska - C4, 800x2000, RAL 7035		
Vrata spratna automatska - C4, 900x2000, RAL 7035		
Vrata spratna automatska - C4, 1000x2000, RAL 7035		

SPRATNA AUTOMATSKA VRATA - INOX

Fermator
AUTOMATIC DOORS FOR LIFTS

	KM	EUR
Vrata spratna automatska - T2, 700x2000, INOX		
Vrata spratna automatska - T2, 800x2000, INOX		
Vrata spratna automatska - T2, 900x2000, INOX		
Vrata spratna automatska - T2, 1000x2000, INOX		
Vrata spratna automatska - T2, 1100x2000, INOX		
Vrata spratna automatska - T2, 1200x2000, INOX		
Vrata spratna automatska - T2, 1300x2000, INOX		
Vrata spratna automatska - T2, 1400x2000, INOX		
Vrata spratna automatska - T2, 1500x2000, INOX		
Vrata spratna automatska - C4, 700x2000, INOX		
Vrata spratna automatska - C4, 800x2000, INOX		
Vrata spratna automatska - C4, 900x2000, INOX		
Vrata spratna automatska - C4, 1000x2000, INOX		

KABINSKA AUTOMATSKA VRATA - EPOXI

Fermator
AUTOMATIC DOORS FOR LIFTS

	KM	EUR
Vrata kabinska autom. VVVF- T2, 700x2000, RAL 7035		
Vrata kabinska autom. VVVF- T2, 800x2000, RAL 7035		
Vrata kabinska autom. VVVF- T2, 900x2000, RAL 7035		
Vrata kabinska autom. VVVF- T2, 1000x2000, RAL 7035		
Vrata kabinska autom. VVVF- T2, 1100x2000, RAL 7035		
Vrata kabinska autom. VVVF- T2, 1200x2000, RAL 7035		
Vrata kabinska autom. VVVF- T2, 1300x2000, RAL 7035		
Vrata kabinska autom. VVVF- T2, 1400x2000, RAL 7035		
Vrata kabinska autom. VVVF- T2, 1500x2000, RAL 7035		
Vrata kabinska autom. VVVF- C4, 700x2000, RAL 7035		
Vrata kabinska autom. VVVF- C4, 800x2000, RAL 7035		
Vrata kabinska autom. VVVF- C4, 900x2000, RAL 7035		
Vrata kabinska autom. VVVF- C4, 1000x2000, RAL 7035		

KABINSKA AUTOMATSKA VRATA - INOX

Fermator
AUTOMATIC DOORS FOR LIFTS

		KM	EUR
Vrata kabinska autom. VVVF- T2, 700x2000, INOX			
Vrata kabinska autom. VVVF- T2, 800x2000, INOX			
Vrata kabinska autom. VVVF- T2, 900x2000, INOX			
Vrata kabinska autom. VVVF- T2, 1000x2000, INOX			
Vrata kabinska autom. VVVF- T2, 1100x2000, INOX			
Vrata kabinska autom. VVVF- T2, 1200x2000, INOX			
Vrata kabinska autom. VVVF- T2, 1300x2000, INOX			
Vrata kabinska autom. VVVF- T2, 1400x2000, INOX			
Vrata kabinska autom. VVVF- T2, 1500x2000, INOX			
Vrata kabinska autom. VVVF- C4, 700x2000, INOX			
Vrata kabinska autom. VVVF- C4, 800x2000, INOX			
Vrata kabinska autom. VVVF- C4, 900x2000, INOX			
Vrata kabinska autom. VVVF- C4, 1000x2000, INOX			

KABINSKA RUČNA VRATA



		KM	EUR
Vrata kabinska jednokrilna ručna 700x2000, RAL 7010			
Vrata kabinska jednokrilna ručna 800x2000, RAL 7010			
Vrata kabinska jednokrilna ručna 900x2000, RAL 7010			
Vrata kabinska jednokrilna ručna 1000x2000, RAL 7010			
Vrata kabinska dvokrilna ručna 1200x2000, RAL 7010			
Vrata kabinska dvokrilna ručna 1300x2000, RAL 7010			
Vrata kabinska dvokrilna ručna 1400x2000, RAL 7010			
Vrata kabinska dvokrilna ručna 1500x2000, RAL 7010			

KABINSKA BUS VRATA



		KM	EUR
Vrata kabinska za modernizaciju BUS -700x2000			
Vrata kabinska za modernizaciju BUS -750x2000			
Vrata kabinska za modernizaciju BUS -800x2000			
Vrata kabinska za modernizaciju BUS -850x2000			
Vrata kabinska za modernizaciju BUS -900x2000			